

SYSTEM LAPITEC V- FIXING WITH RIVET

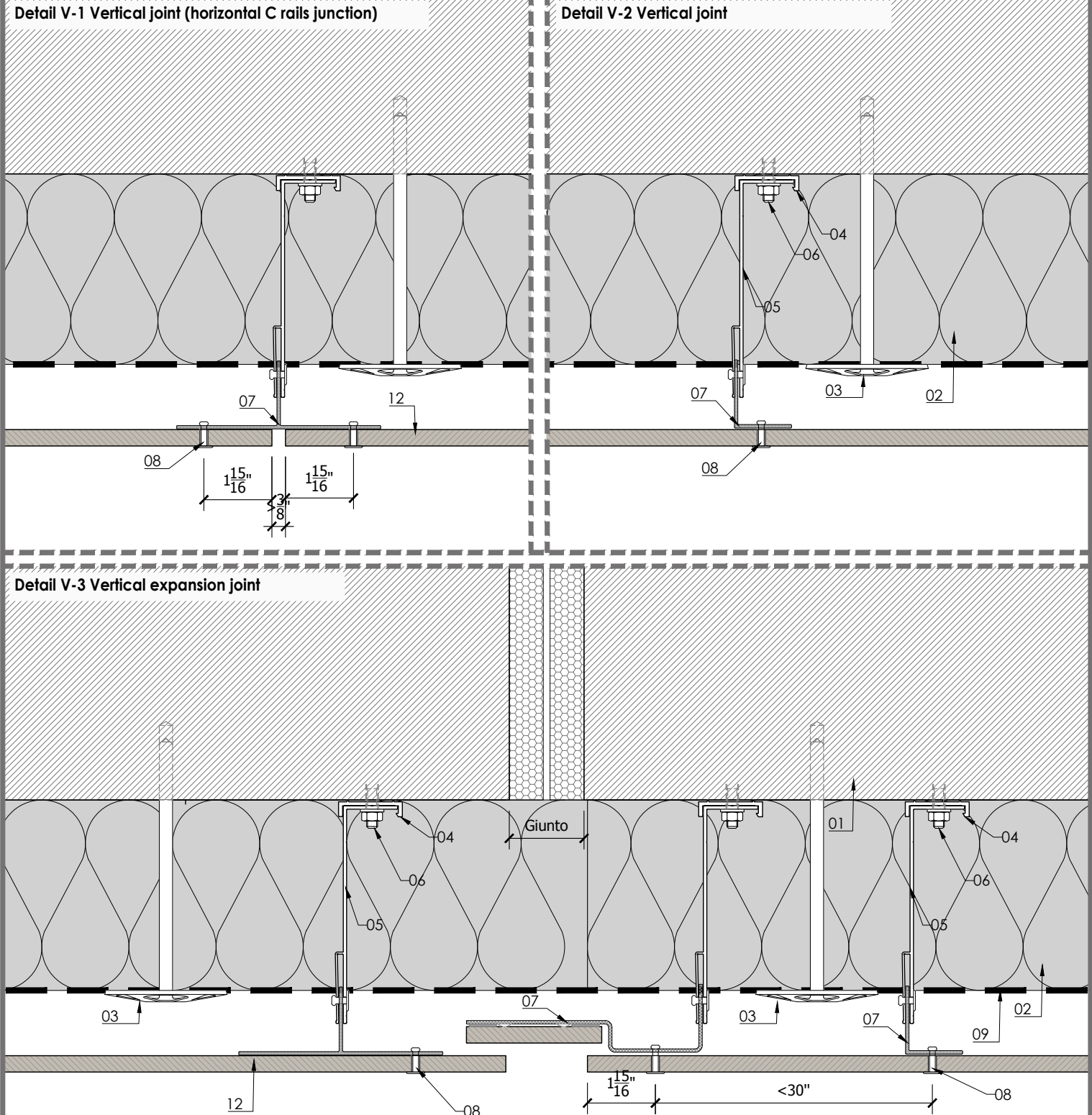

MATERIALS:

- 01 - Support (eg: concrete, core bricks ...)
- 02 - Insulation layer (eg: mineral wool ...)
- 03 - Insulation layer fixing element
- 04 - Thermo-stop

- 05 - Bracket (eg: aluminium, galvanised steel ...)
- 06 - Anchor
- 07 - Vertical profile
- 08 - Rivet SFS
- 09 - Vapour barrier

- 10 - Horizontal rail
- 11 - Stainless steel fixings
- 12 - Lapitec 12 mm thickness
- 13 - Flashing

SYSTEM LAPITEC V- FIXING WITH RIVET

Detail V-4 Window jamb solution with flashing

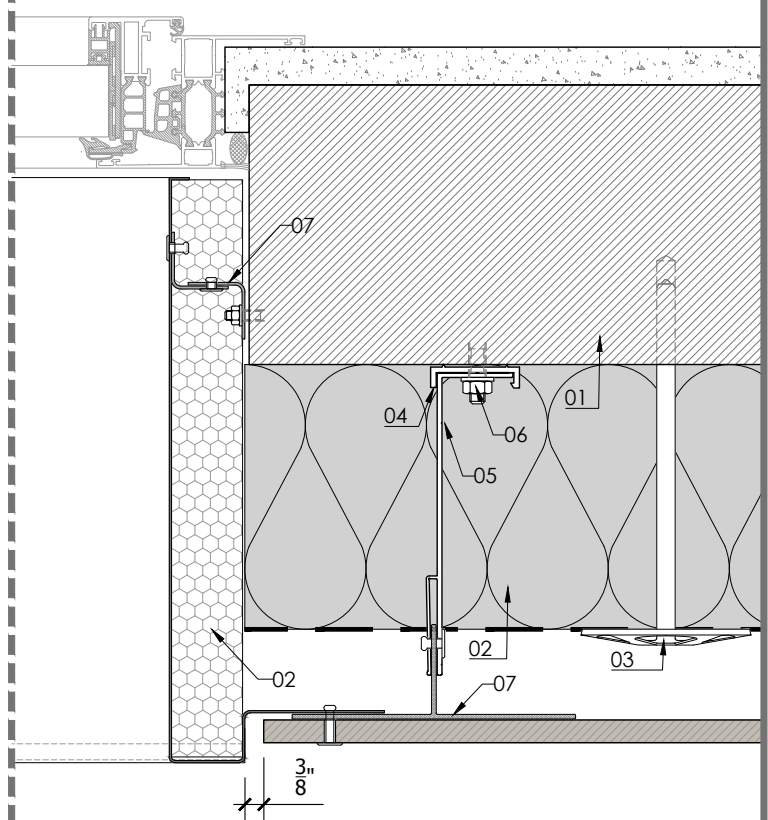
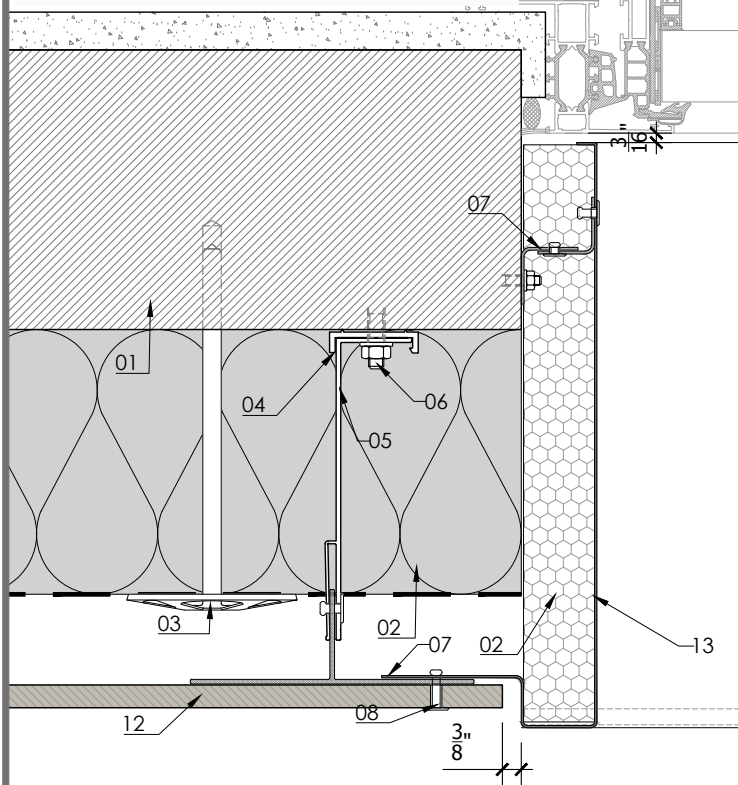

Detail V-5 Window jamb solution with Lapitec

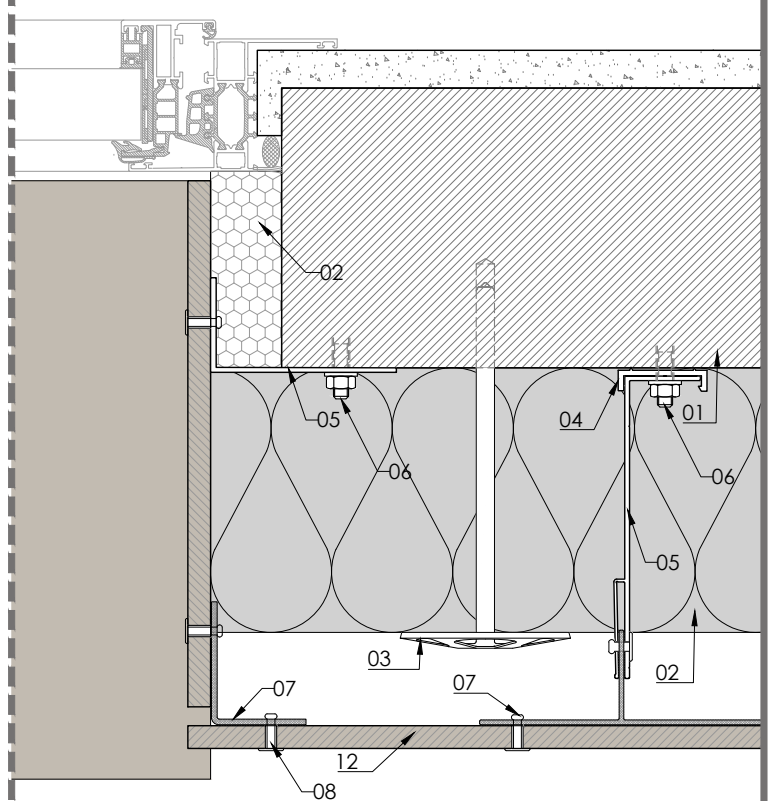
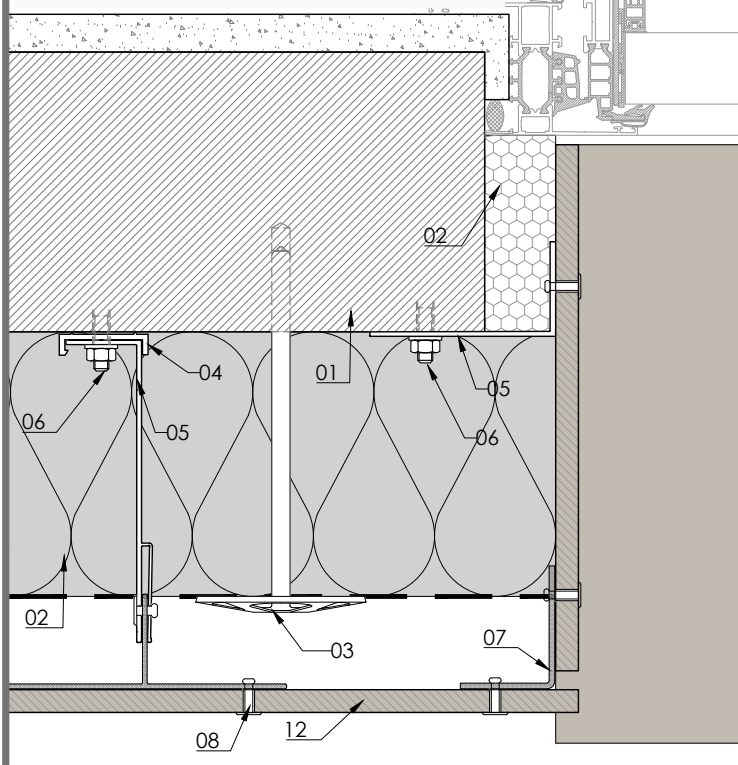

MATERIALS:

- 01 - Support (eg: concrete, core bricks ...)
- 02 - Insulation layer (eg: mineral wool ...)
- 03 - Insulation layer fixing element
- 04 - Thermo-stop

- 05 - Bracket (eg: aluminium, galvanised steel ...)
- 06 - Anchor
- 07 - Vertical profile
- 08 - Rivet SFS
- 09 - Vapour barrier

- 10 - Horizontal rail
- 11 - Stainless steel fixings
- 12 - Lapitec 12 mm thickness
- 13 - Flashing

SYSTEM LAPITEC V- FIXING WITH RIVET

Detail V- 6 Outer corner

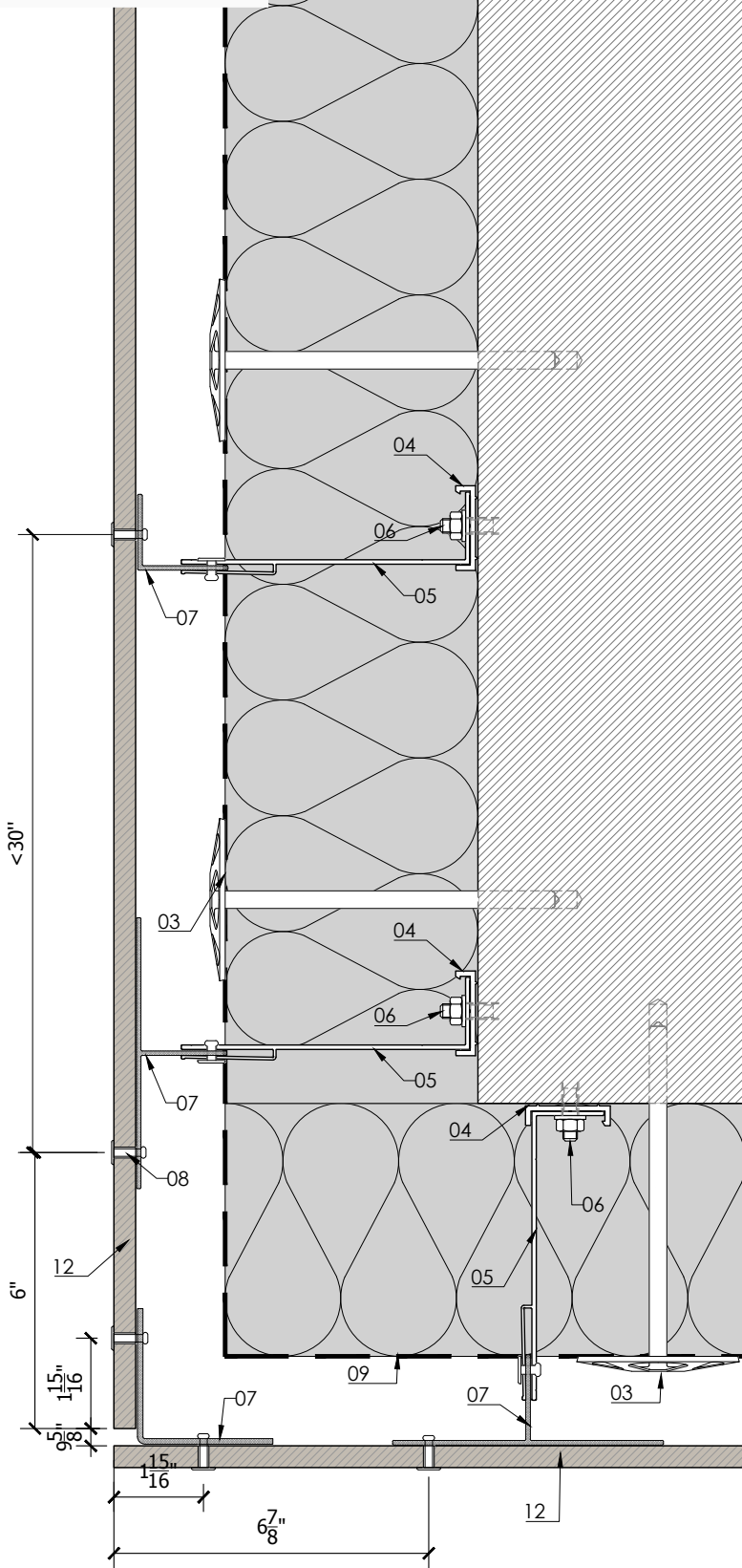

Detail V-7 Outer corner solution with flashing

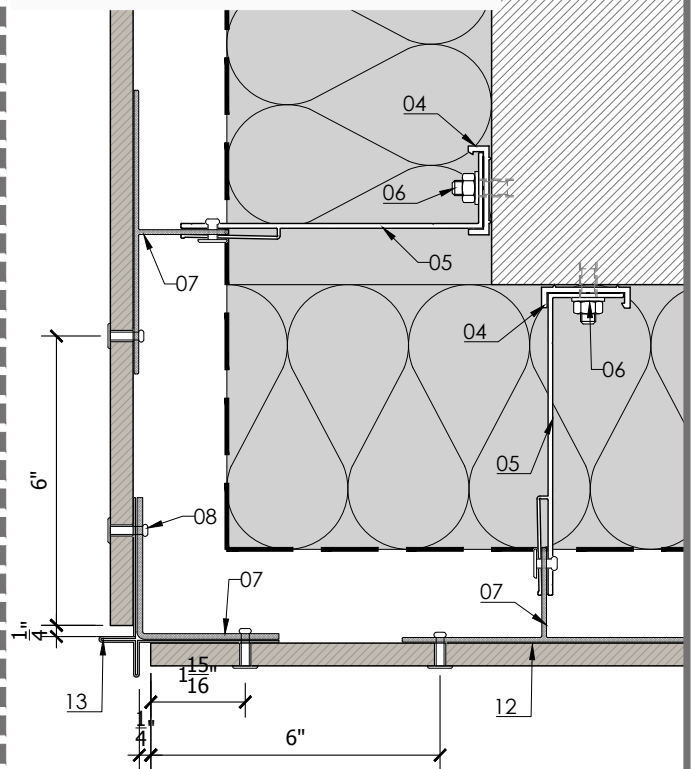

Detail V-8 Outer corner solution with beveled slabs

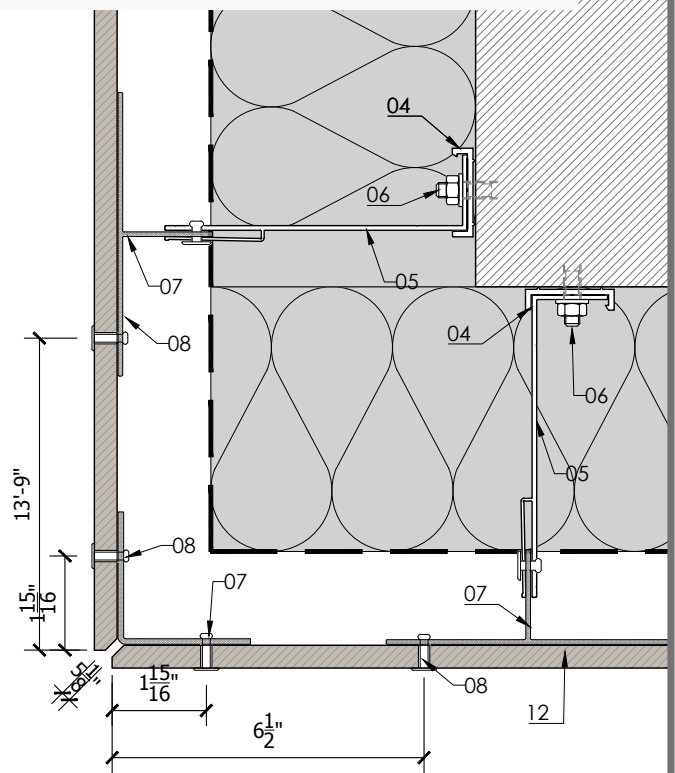

MATERIALS:

- 01 - Support (eg: concrete, core bricks ...)
- 02 - Insulation layer (eg: mineral wool ...)
- 03 - Insulation layer fixing element
- 04 - Thermo-stop

- 05 - Bracket (eg: aluminium, galvanised steel ...)
- 06 - Anchor
- 07 - Vertical profile
- 08 - Rivet SFS
- 09 - Vapour barrier

- 10 - Horizontal rail
- 11 - Stainless steel fixings
- 12 - Lapitec 12 mm thickness
- 13 - Flashing

SYSTEM LAPITEC V- FIXING WITH RIVET

Detail V-9 Inner corner solution with beveled slabs

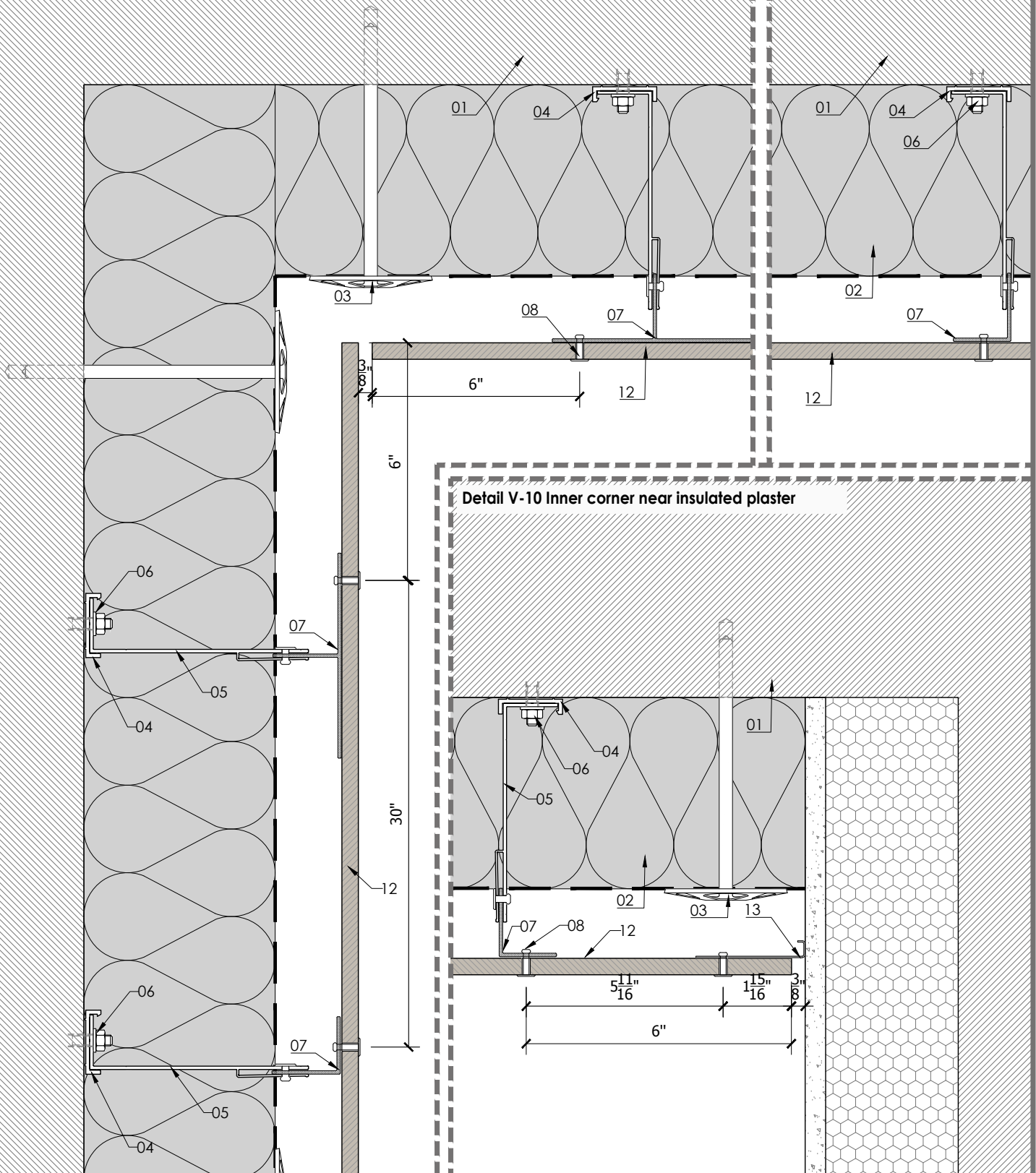

MATERIALS:

- 01 - Support (eg: concrete, core bricks ...)
- 02 - Insulation layer (eg: mineral wool ...)
- 03 - Insulation layer fixing element
- 04 - Thermo-stop

- 05 - Bracket (eg: aluminium, galvanised steel ...)
- 06 - Anchor
- 07 - Vertical profile
- 08 - Rivet SFS
- 09 - Vapour barrier

- 10 - Horizontal rail
- 11 - Stainless steel fixings
- 12 - Lapitec 12 mm thickness
- 13 - Flashing

SYSTEM LAPITEC V- FIXING WITH RIVET

Detail V-11 Horizontal joint (T profiles junction)

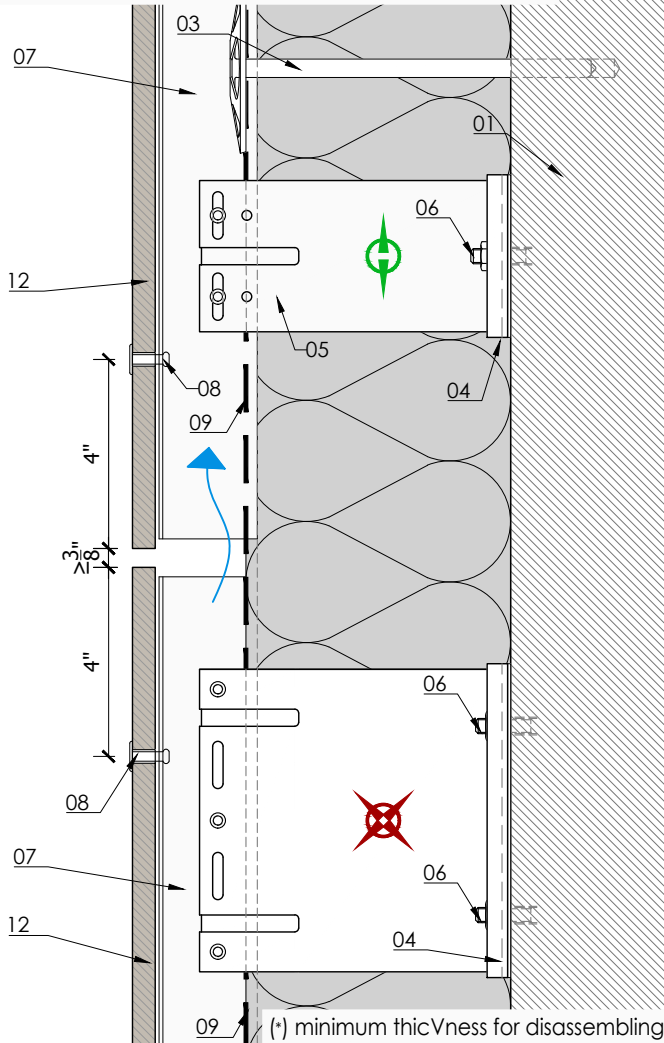

Detail V-13 Baseboard termination with insulation

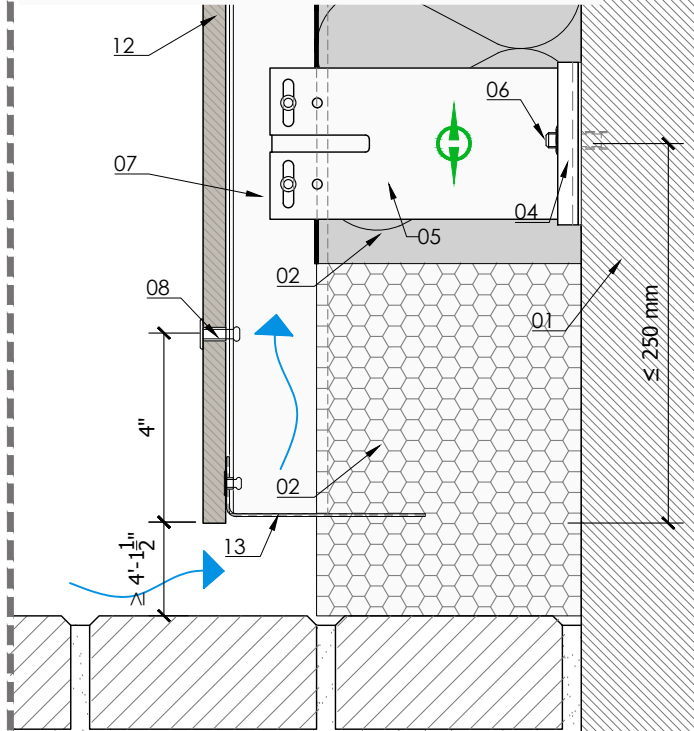

Detail V-14 Baseboard termination without insulation

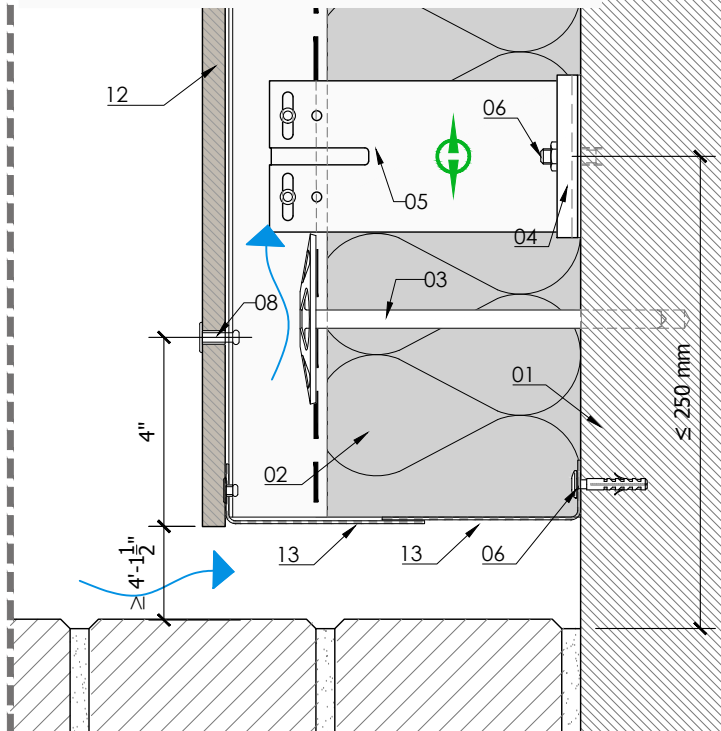

Detail V-12 Horizontal joint

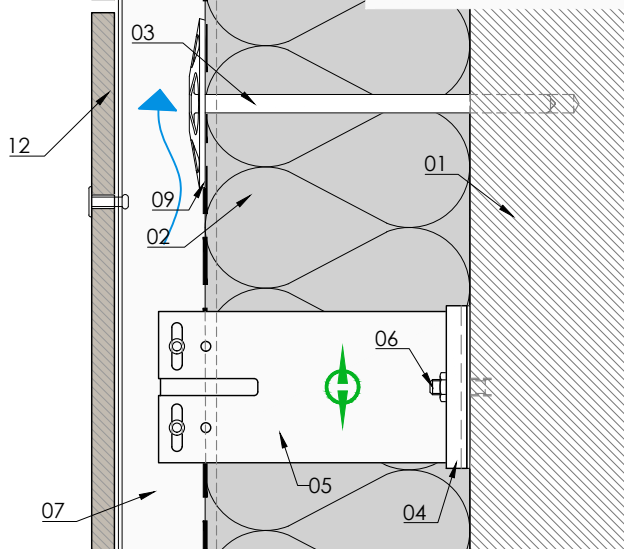

MATERIALS:

- 01 - Support (eg: concrete, core bricks ...)
- 02 - Insulation layer (eg: mineral wool ...)
- 03 - Insulation layer fixing element
- 04 - Thermo-stop

- 05 - Bracket (eg: aluminium, galvanised steel ...)
- 06 - Anchor
- 07 - Vertical profile
- 08 - Rivet SFS
- 09 - Vapour barrier

- 10 - Horizontal rail
- 11 - Stainless steel fixings
- 12 - Lapitec 12 mm thickness
- 13 - Flashing

SYSTEM LAPITEC V- FIXING WITH RIVET

Detail V-15 Parapet termination solution with invisible flashing

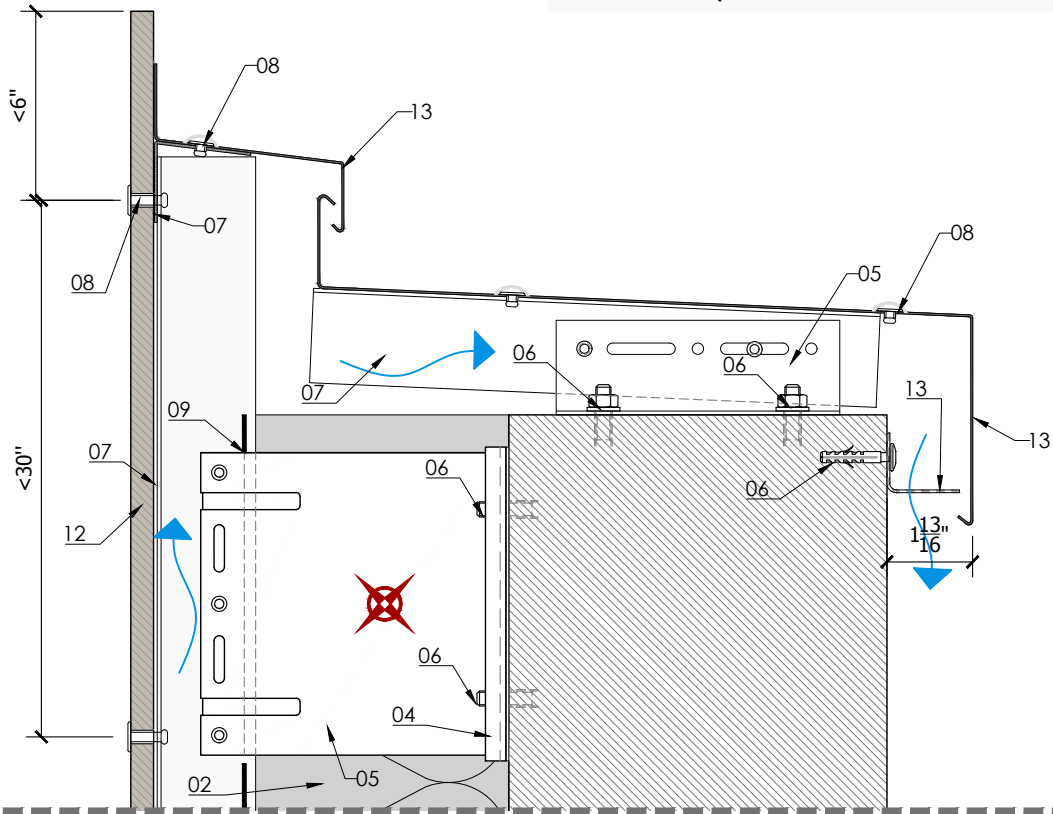

Detail V-16 Parapet termination solution with visible flashing

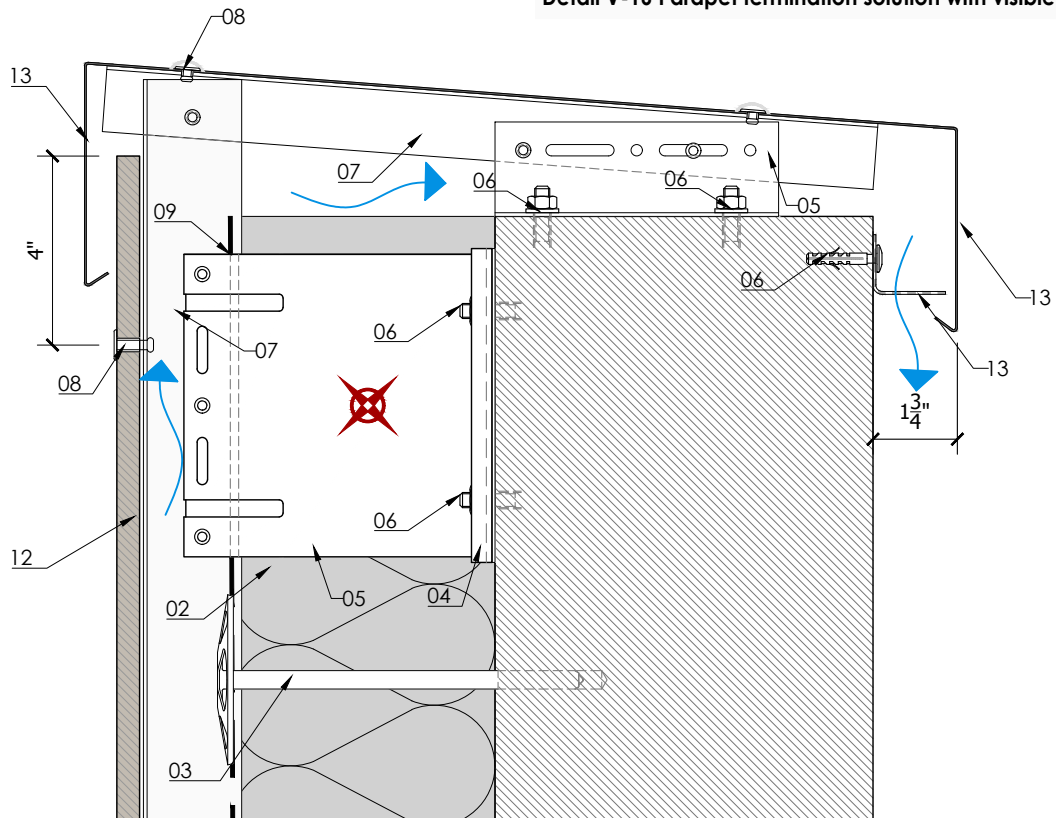

MATERIALS:

01 - Support (eg: concrete, core bricks ...)
02 - Insulation layer (eg: mineral wool ...)
03 - Insulation layer fixing element
04 - Thermo-stop

05 - Bracket (eg: aluminium, galvanised steel ...)
06 - Anchor
07 - Vertical profile
08 - Rivet SFS
09 - Vapour barrier

10 - Horizontal rail
11 - Stainless steel fixings
12 - Lapitec 12 mm thickness
13 - Flashing

SYSTEM LAPITEC V- FIXING WITH RIVET

Detail V-17 Window lintel solution with flashing

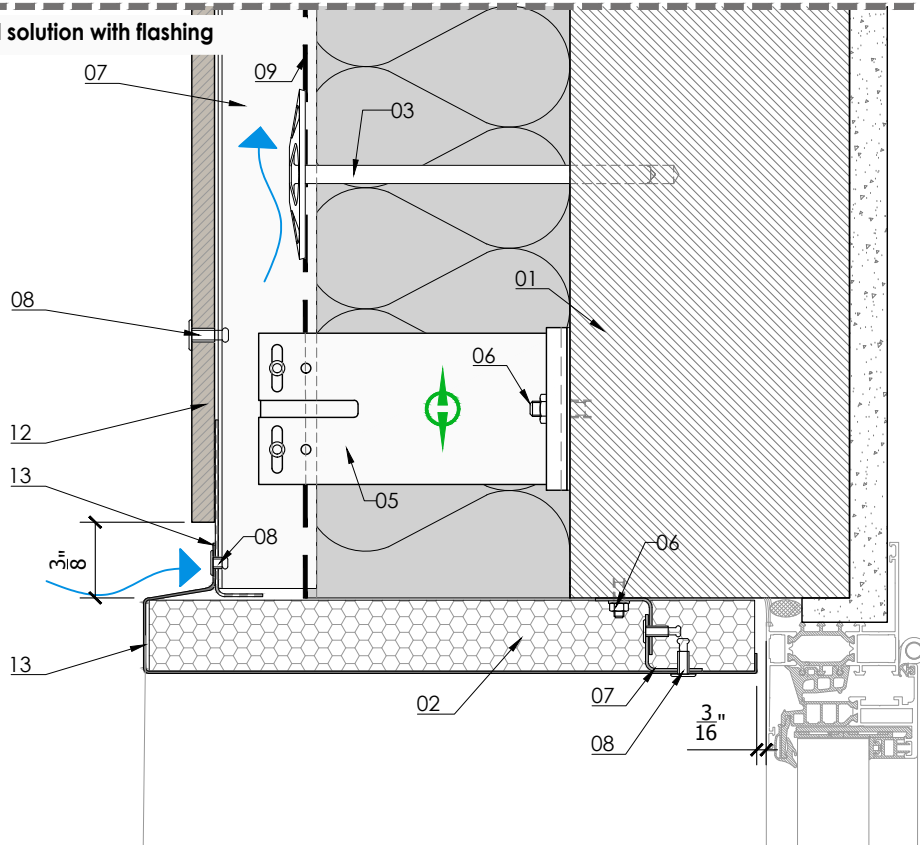

Detail V-18 Windowsill solution with flashing

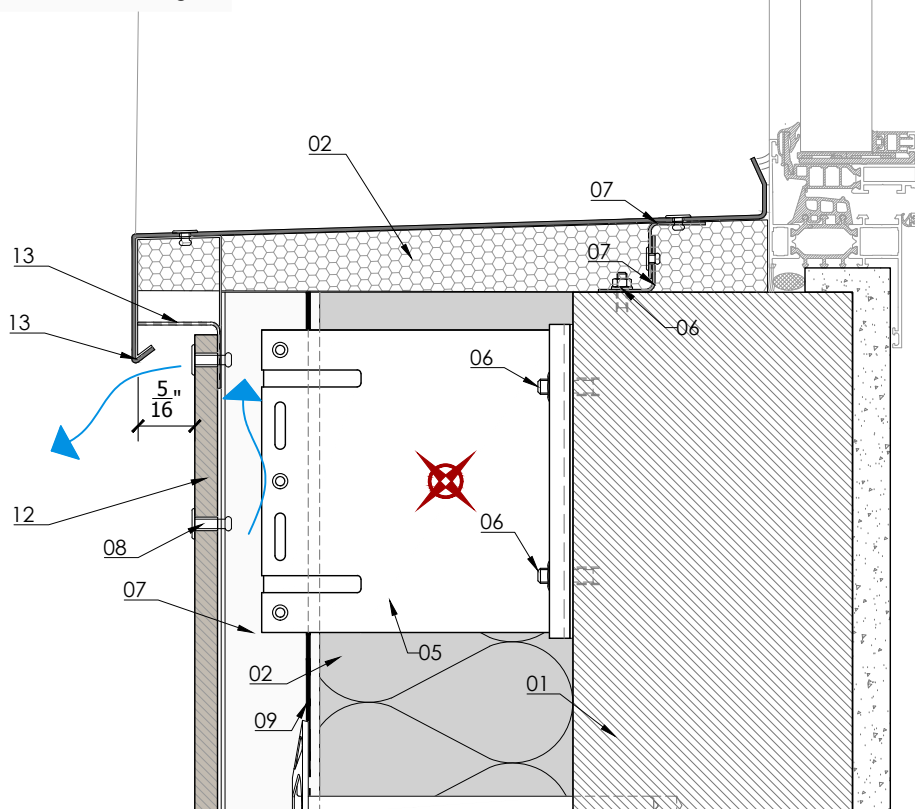

MATERIALS:

- 01 - Support (eg: concrete, core bricks ...)
- 02 - Insulation layer (eg: mineral wool ...)
- 03 - Insulation layer fixing element
- 04 - Thermo-stop

- 05 - Bracket (eg: aluminium, galvanised steel ...)
- 06 - Anchor
- 07 - Vertical profile
- 08 - Rivet SFS
- 09 - Vapour barrier

- 10 - Horizontal rail
- 11 - Stainless steel fixings
- 12 - Lapitec 12 mm thickness
- 13 - Flashing

SYSTEM LAPITEC V- FIXING WITH RIVET

Detail V-19 Window lintel solution with Lapitec

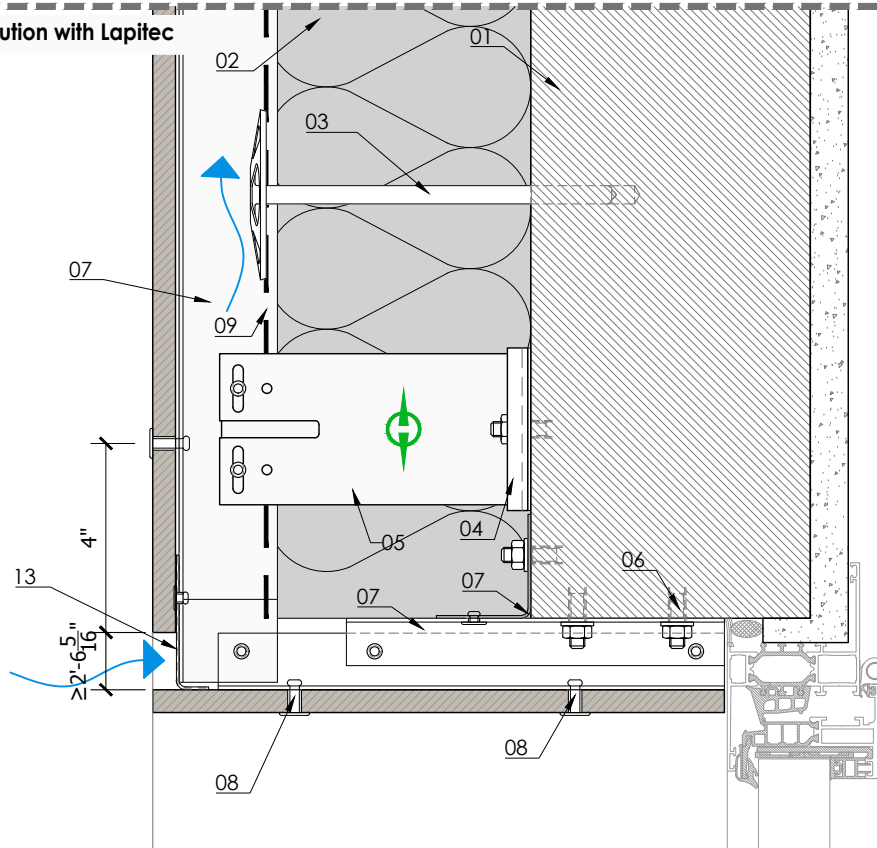

Detail V-20 Windowsill solution with Lapitec

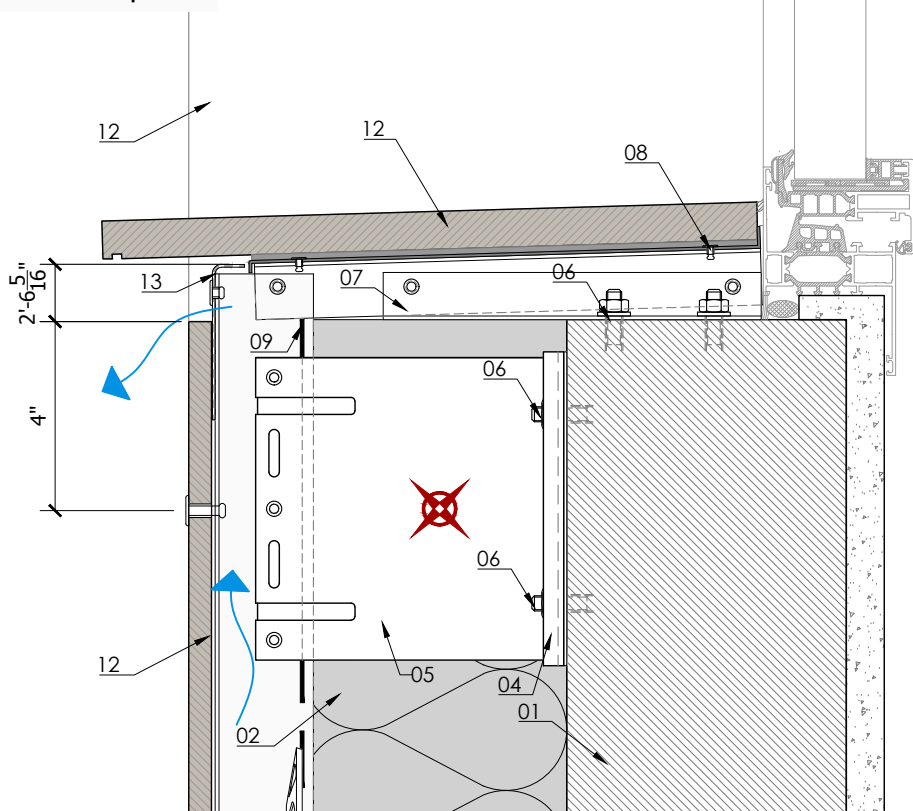

MATERIALS:

- 01 - Support (eg: concrete, core bricks ...)
- 02 - Insulation layer (eg: mineral wool ...)
- 03 - Insulation layer fixing element
- 04 - Thermo-stop

- 05 - Bracket (eg: aluminium, galvanised steel ...)
- 06 - Anchor
- 07 - Vertical profile
- 08 - Rivet SFS
- 09 - Vapour barrier

- 10 - Horizontal rail
- 11 - Stainless steel fixings
- 12 - Lapitec 12 mm thickness
- 13 - Flashing